

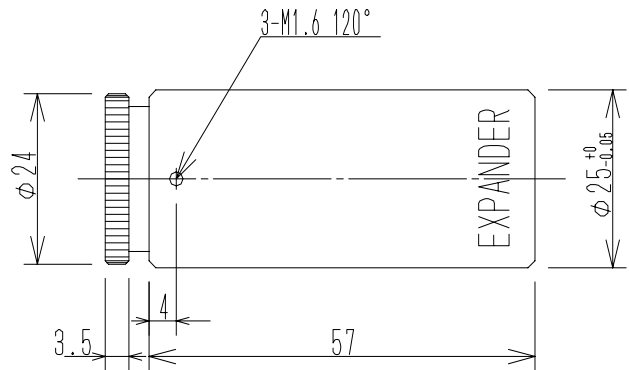

Model EXP0532 Fixed Ratio 532nm Compact Beam Expander with Focus

GEOMATEC Brand Beam Expanders

Designed for High Performance Laser System Applications based on 1064, 532 and 355nm Wavelengths, GEOMATEC Beam Expanders offer the laser system integrator superior performance, high quality and excellent uniformity from unit to unit, in one of the smallest packages found in the industry. GEOMATEC high quality coatings and meticulous manufacturing and quality standards produce a highly reliable unit you can depend on for your laser system.



Model # EXP0532-nX Fixed Ratio Beam Expander for 532nm with Focus Control

P/N	Ratio	Input	Output	Length (L)	Damage Threshold	Transmittance
EXP0532-1.5X	1.5X	8.0mm	12.0mm	63.8	10MW/cm ² (10nS)	≥96%
EXP0532-2X	2X	8.5mm	17.0mm	62.3	10MW/cm ² (10nS)	≥96%
EXP0532-3X	3X	6.0mm	18.0mm	62.4	10MW/cm ² (10nS)	≥96%
EXP0532-4X	4X	5.0mm	20.0mm	63.6	10MW/cm ² (10nS)	≥96%
EXP0532-6X	6X	3.0mm	18.0mm	63.5	10MW/cm ² (10nS)	≥96%
EXP0532-8X	8X	2.0mm	16.0mm	63.8	10MW/cm ² (10nS)	≥96%
EXP0532-10X	10X	1.8mm	18.0mm	64.8	10MW/cm ² (10nS)	≥96%

All dimensions in millimeters unless specified otherwise, specifications subject to change without notice.

BeamExpander.com LLC, Canton, MA, USA Tel: 781-255-1063